

ASSEMBLY INSTRUCTION

DESCRIPTION : STORAGE CABINET

MODEL : HM 2234.02

!	SOFT DRY CLOTH	CHEMICAL	HEAT	KEEP DRY	HANDLE WITH CARE	DO NOT USE KNIFE

HARDWARE		PART LIST	
A	A1	MINIFIX (HOUSING)	13 SETS
	A2	MINIFIX (EURO 24)	13
	B	MINIFIX CAP	13
	C	WOOD DOVEL 8 X 25	18
	D	METAL SHELF SUPPORT	8
	E	16MM CD SCREW MAX 30MM	56
	F	38MM CD SCREW MAX 30MM	16
	G	60MM CD SCAP WOOD 100MM	2
	H	HINGES 5/8	4 SETS
	I	HINGES 2/8	4 SETS
	J	NAIL 5/8	44
	K	ALLEN KEY	1
	L	L1 DRAWER SLIDE 14" (GLCR)	2 SETS
		L2 DRAWER SLIDE 14" (DUDR)	2 SETS

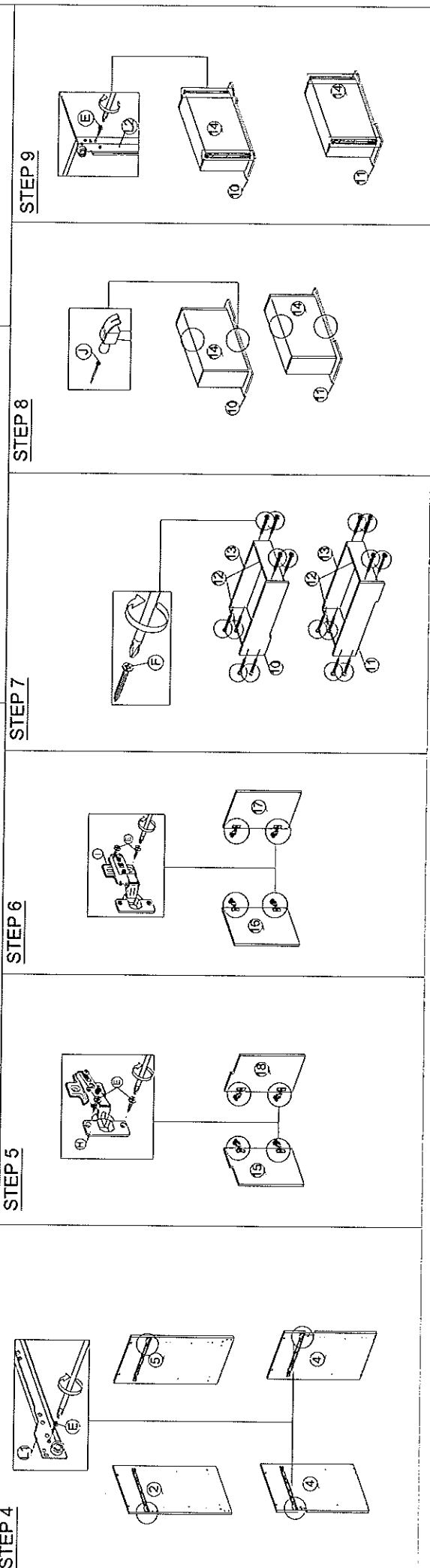
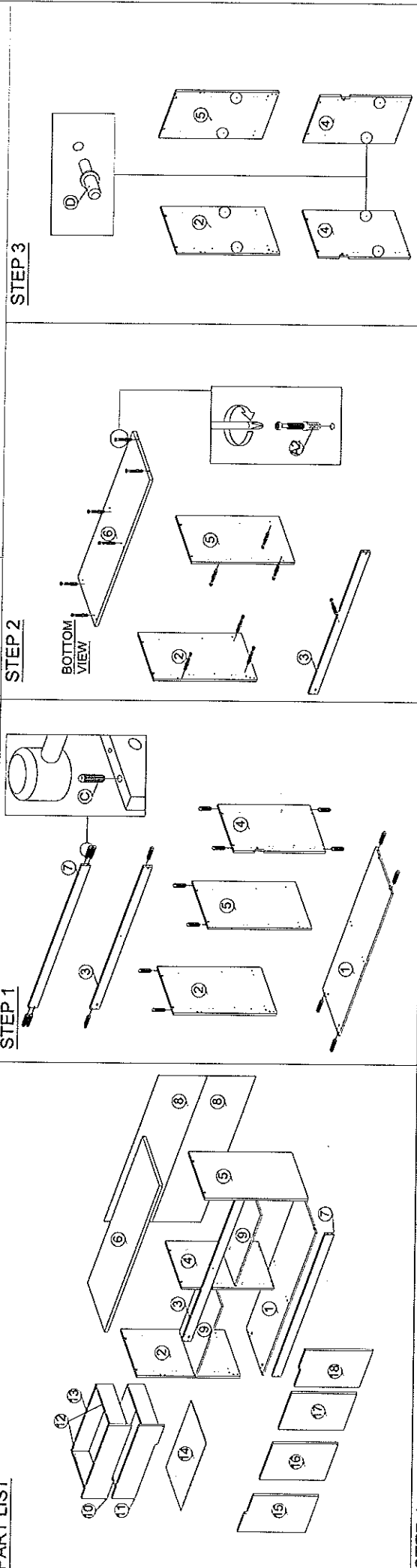



SOFT DRY CLOTH

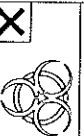

CHEMICAL



HEAT

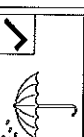

KEEP DRY

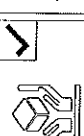

HANDLE WITH CARE

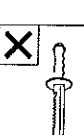

DO NOT USE KNIFE

ASSEMBLY INSTRUCTION

MODEL : HM 2234.02

DESCRIPTION : STORAGE CABINET

STEP 10

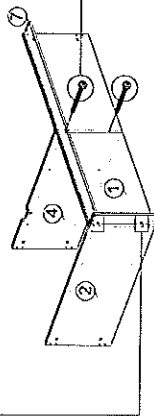
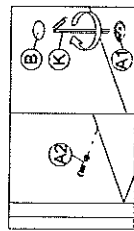

STEP 11

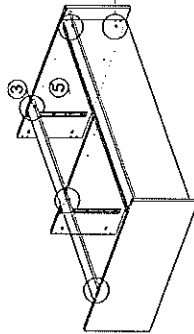
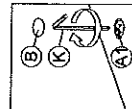
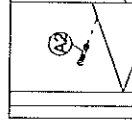

STEP 12

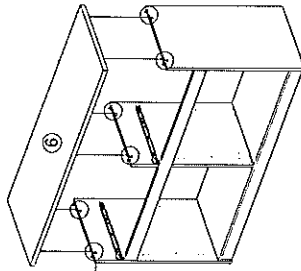
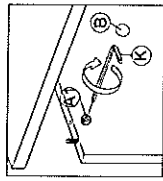

STEP 13

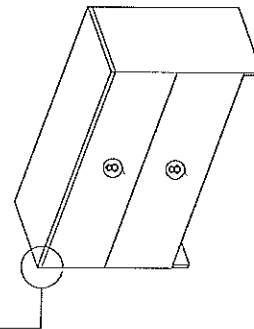
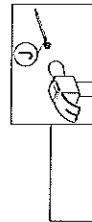

STEP 14

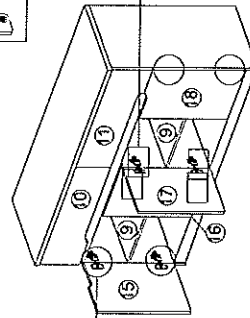
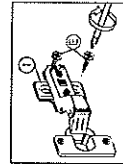
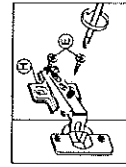

COMPLETED

