

MODEL : HM 2224

# ASSEMBLY INSTRUCTION

DESC : DESK

STEP 9

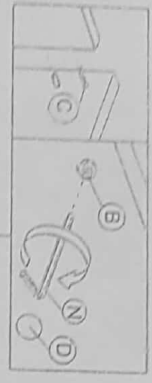

STEP 10

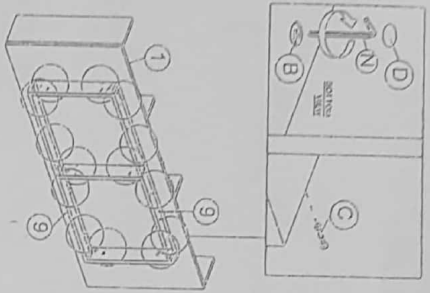

STEP 11

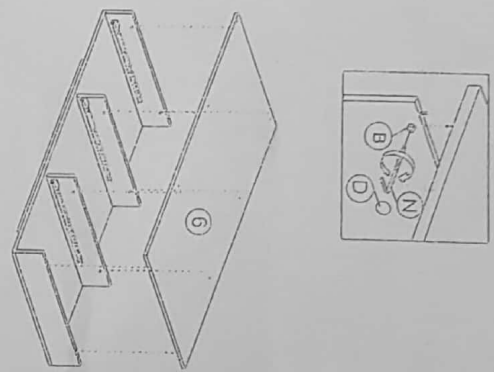

STEP 12

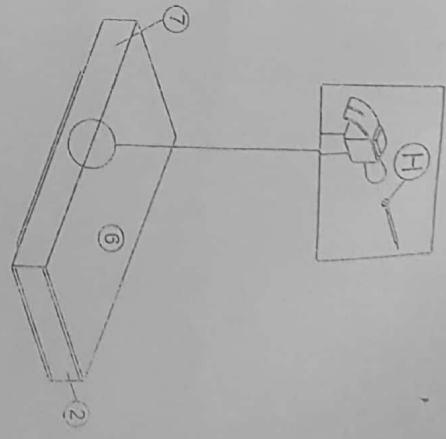

STEP 13

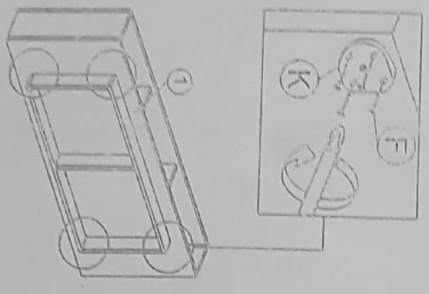

STEP 14

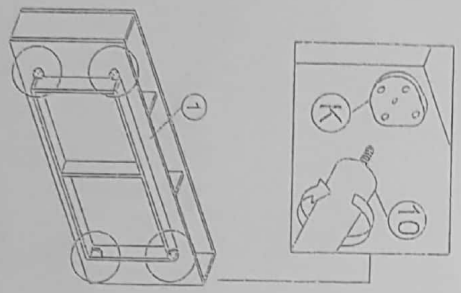

STEP 15

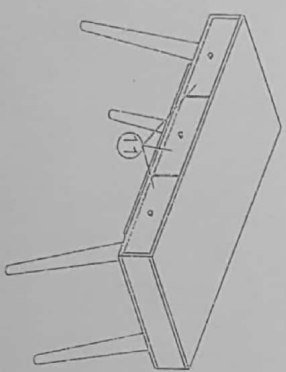

COMPLETED

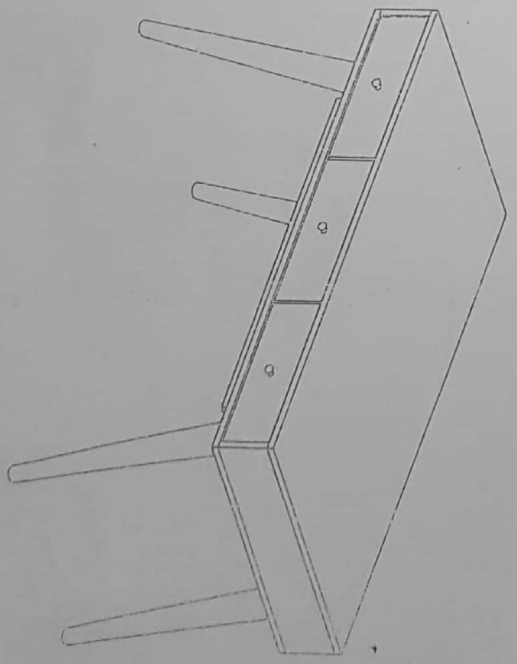

# ASSEMBLY INSTRUCTION

MODEL : HM 2224

DESC : DESK

PART LIST		HARDWARE	
A	22	1	WOOD SCREW 2.5 X 25
B	28	1	WOOD SCREW 2.5 X 25
C	28	1	WOOD SCREW 2.5 X 25
D	28	1	WOOD SCREW 2.5 X 25
E	24	1	1.25MM 1.25MM 1.25MM
F	16	1	2.0MM 2.0MM 2.0MM
G	36	1	1.5MM 1.5MM 1.5MM
H	46	1	1.5MM 1.5MM 1.5MM
I	3	1	HANDLE 5027 (METAL)
J	3	1	1.25MM 1.25MM 1.25MM
K	4	1	LEG SUPPORT BS
L	8	1	5.0MM 5.0MM 5.0MM
M	3 SET	1	DRIVER SCREW BS
N	1	1	1.5MM 1.5MM 1.5MM

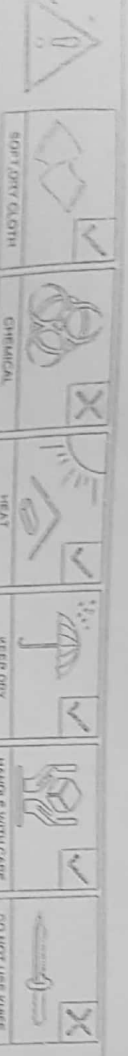

### STEP 1

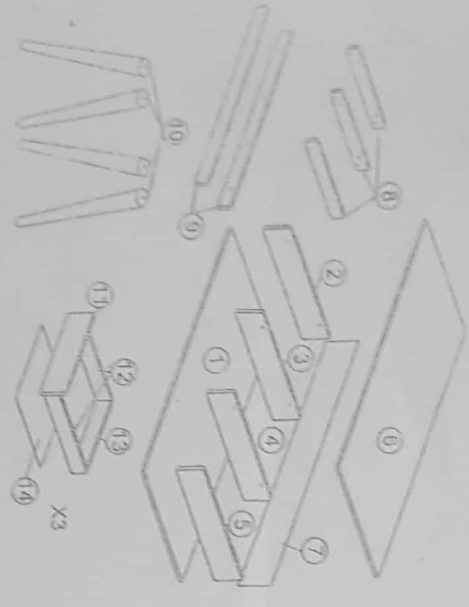

### STEP 2

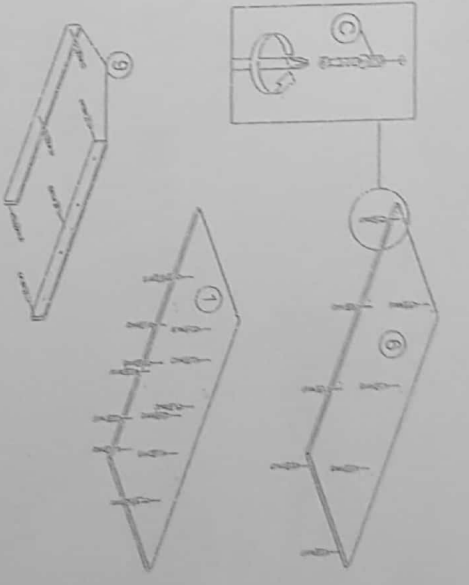

### STEP 3

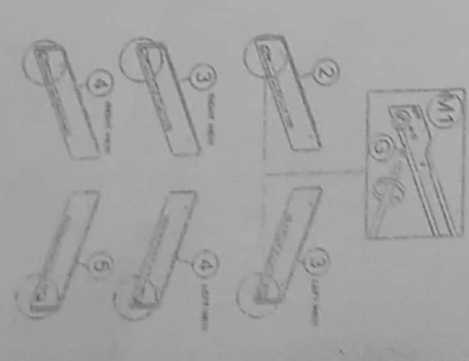

### STEP 4

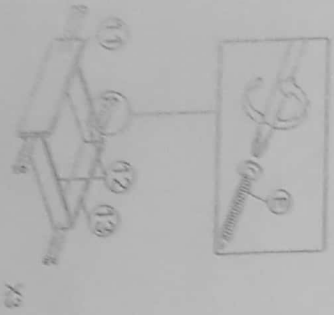

### STEP 5

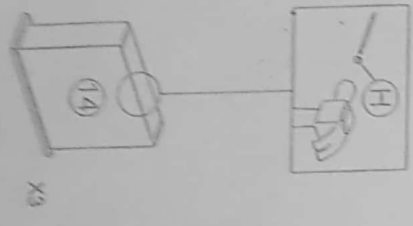

### STEP 6

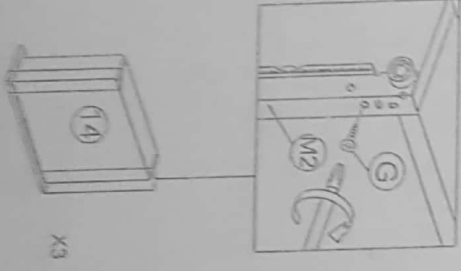

### STEP 7

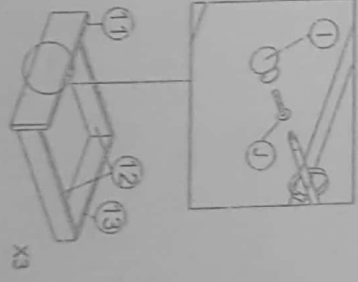

### STEP 8

