

ASSEMBLY INSTRUCTION

MODEL : HM 2225

DESC : SIDE TABLE

HARDWARE

A

WOOD DOWEL 8 X 25
8

B

MINIFIX HOUSING
4

C

MINIFIX EURO 24
4

D

MINIFIX CAP
4

E

CB SCREW M4X38MM
16

F

CB SCREW M4X20MM
16

G

CB SCREW M3.5X16MM
24

H

NAIL 5/8
32

I

HANDLE 5022 (METAL)
2

J

HANDLE SCREW M4X35MM
2

K

LEG SUPPORT 83
4

L

CSK CAP WOOD M6X50MM
4

M

DRAWER SLIDE 14"
2 SET

N

L KEY M4
1

PART LIST

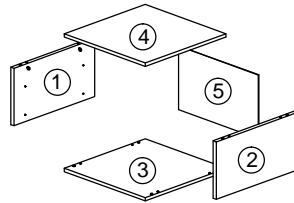
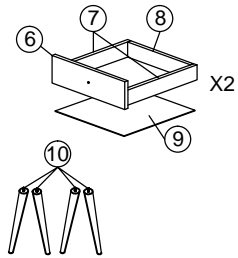

STEP 1

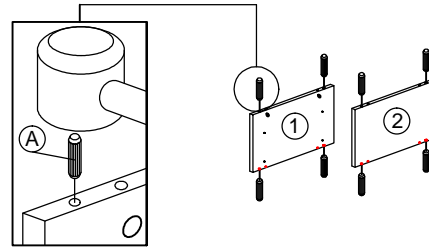

STEP 2

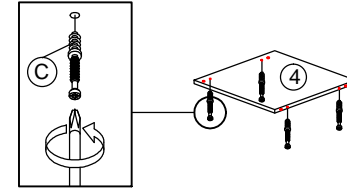

STEP 3

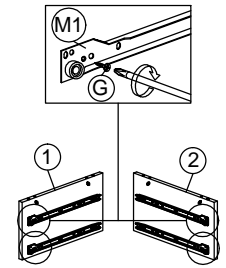

STEP 4

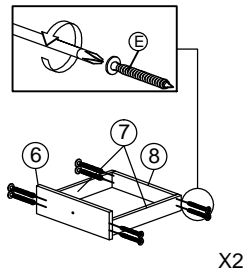

STEP 5

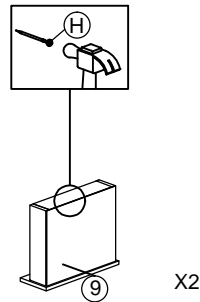

STEP 6

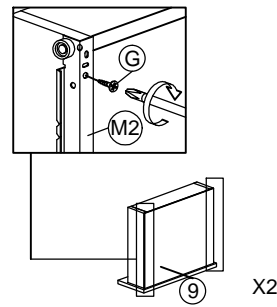

STEP 7

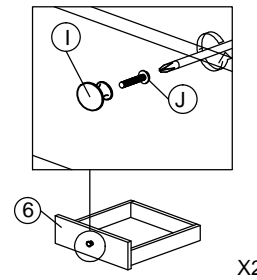

STEP 8

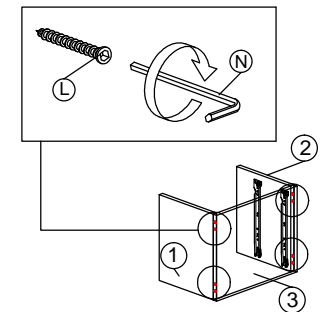

STEP 9

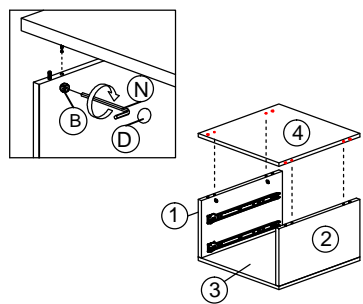

STEP 10

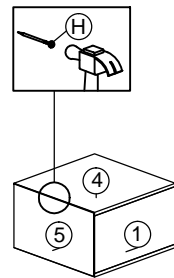

STEP 11

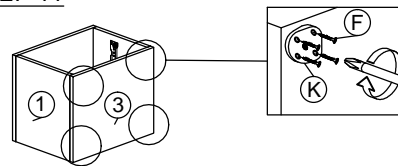

STEP 12

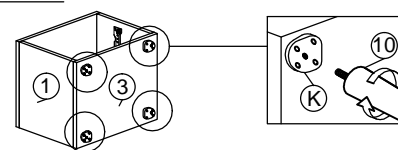

STEP 13

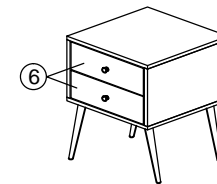

COMPLETED

