

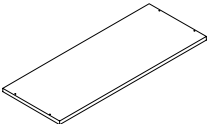

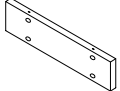
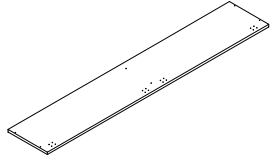
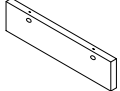
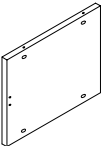
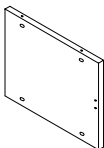
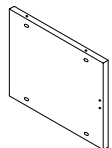
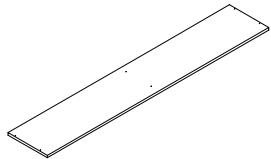
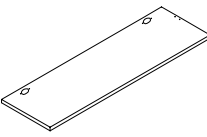
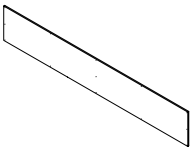
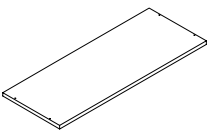
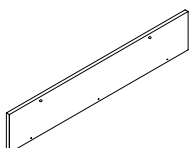
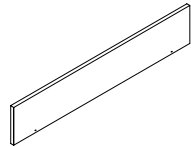
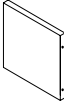
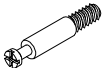

HM8909

1  x1	2  x4	3  x1	4  x1	5  x1
6  x1	7  x1	8  x1	9  x2	10  x1
11  x1	12  x2	13  x2	14  x2	A  x30
B  x30	C  x23	D  x4	E (3.5x12mm)  x32	F  x2
G (6.3x50mm)  x6	H  x4	I (5x50mm)  x8		

Step 1

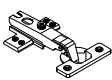

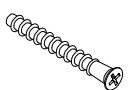
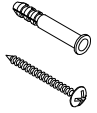
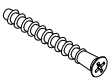
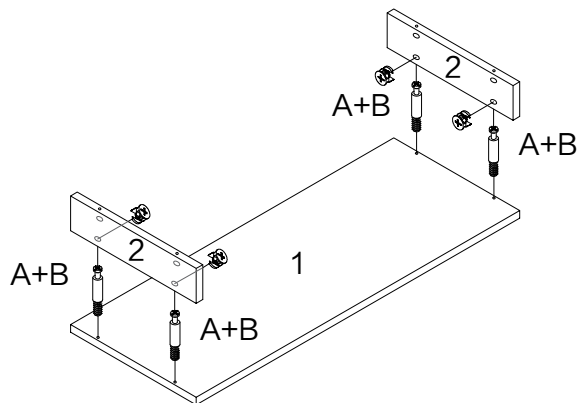
A x4

B x4

Step 2

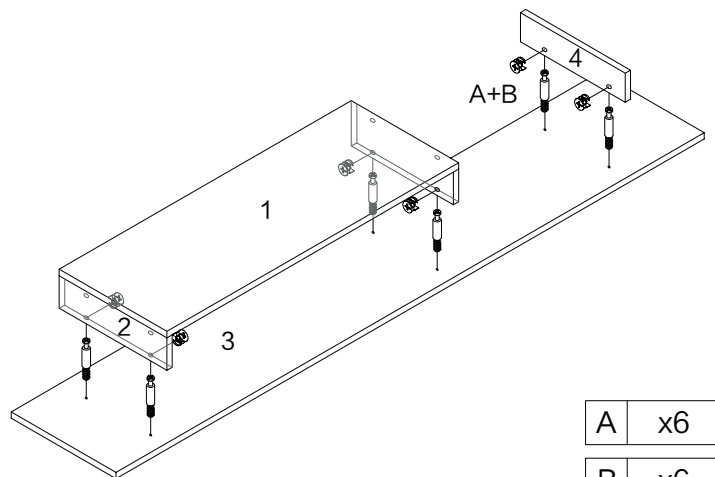

A x6

B x6

Step 3

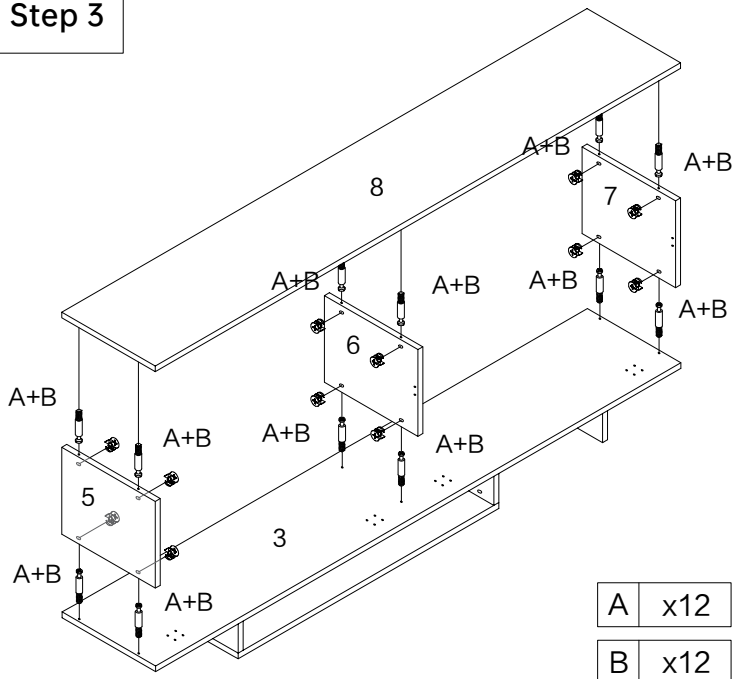

- A x12
- B x12

Step 4

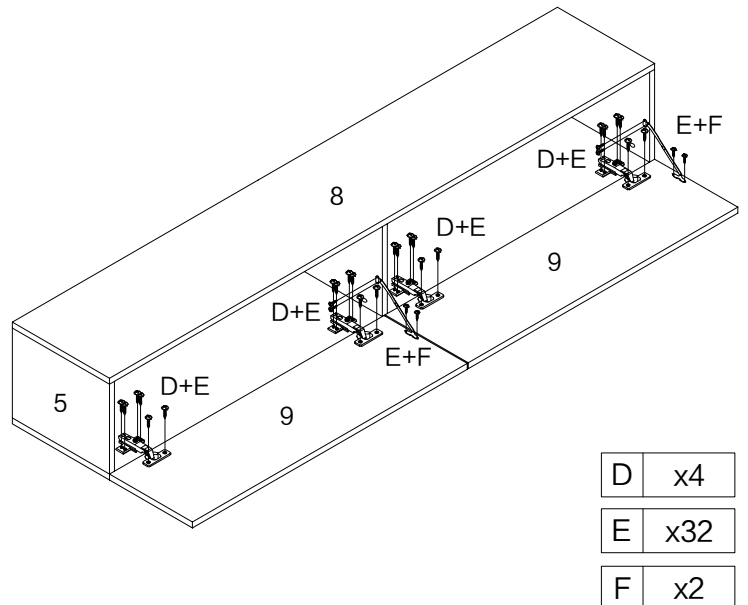

- D x4
- E x32
- F x2

Step 5

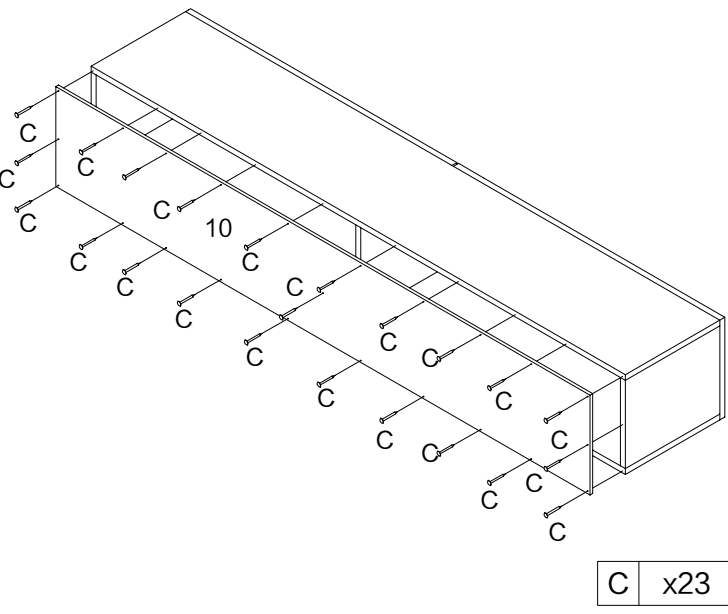

- C x23

Step 6

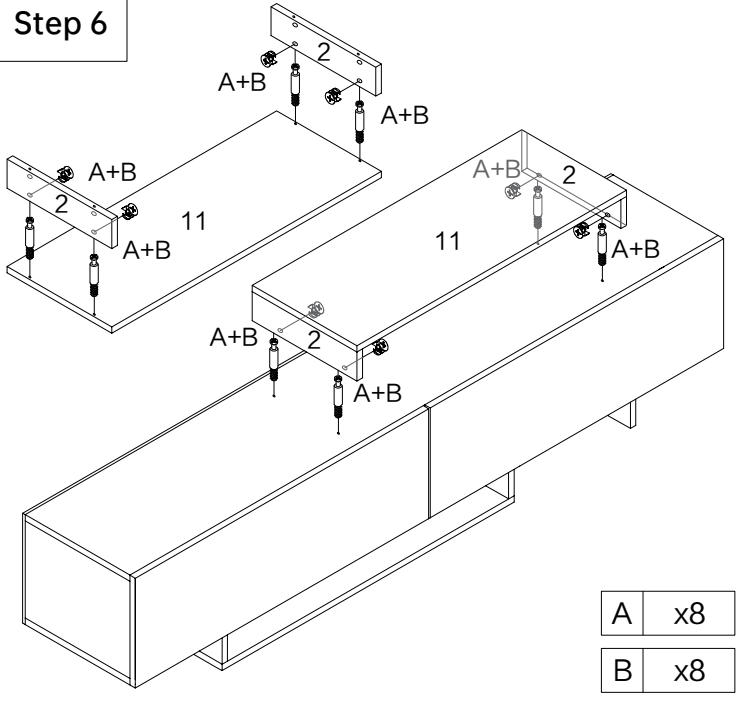

- A x8
- B x8

Step 7

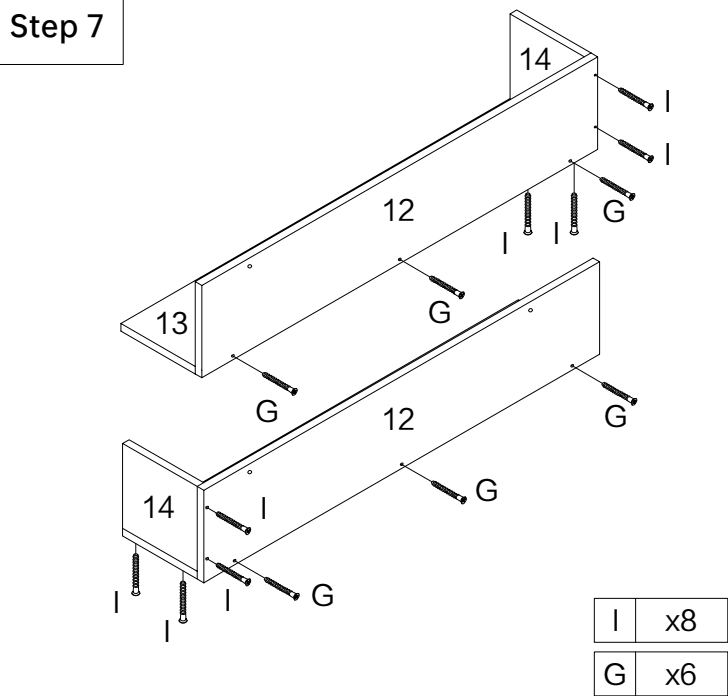

- I x8
- G x6

Complete

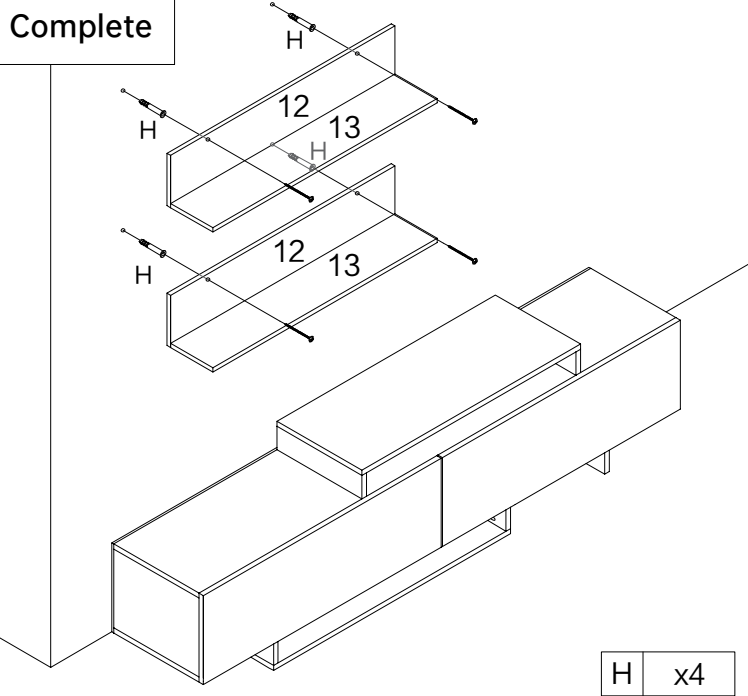

- H x4